

OUTSULATION® RMD SYSTEM™



An Exterior Wall Insulation and Finish System With Moisture Drainage
That Incorporates Continuous Insulation and a Water-Resistive Barrier

DS143

Outsulation RMD System Application Instructions

Table of Contents	
Section I	General Installation Requirements
Section II	Materials Required for Completing Installation of the Outsulation RMD System
Section III	Mixing Instructions
Section IV	Rough Opening Preparation Options
Section V	Substrate Expansion Joint Bridging Options
Section VI	Air/Water-Resistive Barrier Application
Section VII	Accessories and Drainage Options
Section VIII	Insulation Board Installation
Section IX	Installation of Reinforcing Mesh and Base Coat
Section X	Sealant Joint Preparation
Section XI	Dryvit Primers
Section XII	Dryvit Finish
Section XIII	Coatings and Sealers
Section XIV	Maintenance and Repair

I. General Installation Requirements

- A. Project Conditions
1. Storage
 - a. Materials shall be stored at the job site, and at all times, in a cool, dry location, out of direct sunlight, protected from weather and other sources of damage. Minimum storage temperature shall be as follows:
 - 1) DPR, PMR™, HDP™, Weatherlastic®, and E Finishes™, Color Prime™, Primus®, Genesis® And NCB™: 40 °F (4 °C).
 - 2) For all other products, refer to specific product data sheets.
 - b. Maximum storage temperature shall not exceed 100 °F (38° C). **NOTE: Minimize exposure of materials to temperatures over 90 °F (32 °C). Finishes exposed to temperatures over 110 °F (43 °C) for even short periods may exhibit skinning, increased viscosity and should be inspected prior to use.**
 - c. Protect all products from inclement weather and direct sunlight.
 2. Application
 - a. Application of wet materials shall not take place during inclement weather unless appropriate protection is provided. Protect materials from inclement weather until they are completely dry.
 - 1) At the time of Dryvit product application, the air and wall surface temperatures shall be from 40 °F (4 °C) minimum to 100 °F (38° C) maximum for the following products:
 - a) DPR, PMR, HDP, Weatherlastic and E Finishes, Color Prime, Primus, Genesis and NCB: 40 °F (4 °C).
 - b) For all other products, refer to specific product data sheets.
 3. These temperatures shall be maintained with adequate air ventilation and circulation for a minimum of 24 hours (48 hours for Weatherlastic Finishes, Ameristone™, and TerraNeo®) thereafter, or until the products are completely dry. Refer to published product data sheets for more specific information.
- B. Inspection of Substrate
1. Acceptable substrates for application of the Dryvit Outsulation RMD System are listed in the Dryvit Outsulation RMD System Specification, [DS155](#).
 2. The substrate must be securely fastened per contract documents.
 3. The substrate must be clean, dry, structurally sound, free of loose material, voids, projections, hot spots, release agents, coatings, or other materials that may affect adhesion.
 4. There shall be no planar irregularities greater than 1/4 in (6.4 mm) within any 4 ft (1.2 m) radius.
 5. Wood based sheathings require a 1/8 in (3.2 mm) gap between adjacent sheets per the guidelines published by the APA.
- C. Flashing at System Terminations
1. General
 - a. Ensure that flashing is installed in accordance with applicable code requirements and the contract documents. As a minimum, opening preparation is required as shown in the Outsulation RMD System Installation Details, [DS106](#).
 2. Transition at Roof Lines
 - a. Ensure the roof has positive drainage, i.e. all runoff shall be directed to the exterior and away from the structure.
 - b. Roof flashing shall be installed in accordance with industry guidelines, manufacturer's instructions and contract documents.
 - c. Runoff diverters (i.e. kickouts, crickets and saddles) must be installed where required. Particular attention must be paid to the eaves/chimney intersections, sloped roof/wall intersections, scuppers and parapet caps. Refer to the Dryvit Outsulation RMD System Installation Details, [DS106](#) and contract documents.
 - d. Hold system a minimum of 8 in (203 mm) above flat roofs; 2 in (51 mm) above sloped roofs.
 3. Openings
 - a. Heads, jambs and sills of all openings shall be prepared with Dryvit Backstop® NT, AquaFlash® System, Flashing Tape™ or other code approved flashing material selected by the design professional prior to window/door, mechanical equipment, or other component installation. Refer to the Dryvit Outsulation RMD System Installation Details, [DS106](#).
NOTE: Sill piece shall extend to the inside face of wall and continue a minimum of 102 mm (4 in) up at the jambs.
 - b. Continuous flashing at heads of openings as indicated in contract documents.
NOTE: For windows or doors that do not have integral flashing, a field-applied flashing must be installed as required (by others). Refer to the Dryvit Outsulation RMD System Installation Details, [DS106](#).
 - c. Individual windows that are ganged to make multiple units require the heads to be continuously flashed and the joints between the units to be fully sealed.

4. Decks and Patios
 - a. Wood decks shall be properly flashed prior to system application. See the Dryvit Outsulation RMD System Installation Details, [DS106](#) for general information and guidance.
 - b. Verify that the system terminates above poured decks, patios, landings, etc. that are properly sloped and waterproofed to direct water away from the walls.
 5. Utilities
 - a. Provisions must be made to ensure that the system terminates properly at lighting fixtures, electrical outlets, hose bibs, dryer vents, etc. Refer to the Dryvit Outsulation RMD System Installation Details, [DS106](#).
 6. Grade Level Terminations
 - a. Hold system a minimum of 8 in (203 mm) above finished grade.
- D. Sealants
1. Dryvit materials shall be completely dry prior to installation of sealant materials (typically 48 - 72 hours). Humid or cool conditions may require longer drying times.
 2. Sealants and sealant primers are manufactured and supplied by others. Refer to [DS153](#) for a list of sealants that have been tested by the sealant manufacturer's and found to be compatible with Dryvit products.

Notify the general contractor and/or architect and/or owner of all discrepancies. Do not proceed until all unsatisfactory conditions have been corrected.

II. Materials Required for Completing Installation of the Outsulation RMD System

- A. Materials Supplied by Dryvit Systems, Inc.
1. AquaFlash™ and AquaFlash Mesh
 2. Backstop® NT™– Texture, Smooth and Spray, or Backstop® DMS
 3. Grid Tape™
 4. Flashing Tape™ and Flashing Tape Surface Conditioner™
 5. AP Adhesive™
 6. Drainage Strip™
 7. Track – optional
 8. Drainage Mat – when specified
 9. Genesis®, Genesis® DM, Genesis® DMS, Primus®, Primus® DM, Dryflex®
 10. NCB™
 11. Rapidry DM™ 35-50, Rapidry DM™ 50-75, RapidPatch™
 12. Standard Mesh, Standard Plus Mesh, Intermediate Mesh™, Panzer® 15, Panzer® 20, Corner Mesh™, and Detail Mesh®
 - a. It shall be colored blue for product identification bearing the Dryvit logo.
 13. Dryvit Finishes
 14. Dryvit Coatings and Primers
- NOTE: Materials listed above are also listed in the Outsulation RMD Specification, [DS155](#). Typically the project specification will identify the materials necessary to complete application.**
- B. Additional Materials Supplied by Others
1. Portland Cement: Type I or II
 2. Clean Potable Water
 3. Expanded Polystyrene Insulation Board meeting [DS131](#)
 4. Mechanical Fasteners (washers and screws) – when specified
 5. Dupont® Tyvek® Stucco Wrap – when specified
 6. Expanded Metal Lath – when specified
 7. Flashing

III. Mixing Instructions

- A. General
1. No additives such as sand, aggregates, rapid binders, anti-freeze, accelerators, etc. shall be added to any Dryvit materials under any circumstances. **Such additives will adversely affect the performance of the material and void all warranties.**
- B. Air/Water-Resistive Barrier Materials
1. AquaFlash
 - a. Open the bucket with a utility knife or lid-off.
 - b. AquaFlash is ready to use after an initial spin-up using a "Twister" paddle or equivalent mixing blade, powered by a 1/2 in (12.7 mm) drill, at 450 - 500 rpm. Do not add cement or any other additives.
 2. Backstop NT
 - a. Open the bucket with a utility knife or lid-off.

- b. Backstop NT is ready to use after an initial spin-up using a “Twister” paddle or equivalent mixing blade, powered by a 1/2 in (12.7 mm) drill, at 450 - 500 rpm. Do not add cement or any other additives.
- 3. Backstop DMS (can also be used as adhesive)
 - a. See [DS704](#) for mixing instructions.
- C. Adhesive and Base Coat
 - 1. Primus or Genesis
 - a. Open the bucket with a utility knife or lid-off.
 - b. Due to shipping and storage, there may be some separation of materials. Prior to splitting the material and adding Portland cement, mix the material thoroughly. Use a “Twister” paddle or equivalent mixing blade powered by a 1/2 in (12.7 mm) drill, at 500 - 1200 rpm only. **NOTE: A minimum 7 amp drill works best for Portland cement based materials. CAUTION: Do not over-mix or use other types of mixing blades as air entrapment and product damage may occur and result in workability and performance problems.**
 - c. Pour 1/2 of the freshly mixed material [approximately 30 lbs (13.5 kg)] into a clean plastic container.
 - d. Add 1/3 of a bag [approximately 30 lbs (13.5 kg)] of fresh, lump free Type I or II Portland cement. Either gray or white cement is acceptable. Add cement slowly and mix thoroughly. **Do not add large quantities of cement at one time.**
 - e. Clean potable water may be added to the mixture to adjust the workability.
 - 1) Primus
 - a) Add as little water as possible, in small increments, and only after the Portland cement is thoroughly mixed. **Do not over water as this will degrade the performance and promote efflorescence.**
 - b) Mix the Primus material with Portland cement thoroughly; then wait five (5) minutes and mix again to break the initial set. Retempering with a small amount of water is permissible provided the mixture has not set. The mixture has a pot life similar to other Portland cement plaster material. Mix only as much material as can be conveniently used during a work period.
 - 2) Genesis
 - a) Add 1 qt (950 ml) of water prior to adding Portland cement. Additional water may be added to adjust workability.
 - b) Mix the Genesis material with Portland cement thoroughly; then wait ten to fifteen (10 - 15) minutes and mix again to break the initial set. Retempering with a small amount of water is permissible provided the mixture has not set. The mixture has a pot life similar to other Portland cement plaster material. Mix only as much material as can be conveniently used during a work period.
 - 2. Primus DM
 - a. Pail Mixing
 - 1) One 50 lb (23 kg) bag of material will produce approximately 5 gal (19 L) of Primus DM mixture. Add 1.5 gal (5.7 L) of clean potable water into a clean plastic container.
 - 2) Add Primus DM slowly while mixing using a “Twister” paddle or equivalent mixing blade, powered by a 1/2 in (12.7 mm) drill, at 500 - 1200 rpm. **NOTE: A minimum 7 amp drill works best for Portland cement based materials.**
 - 3) Thoroughly mix until uniformly wetted, adjusting consistency with a small amount of water or Primus DM material.
 - 4) Allow the mixture to set a minimum of five (5) minutes then retemper, adding a small amount of water if necessary. Material must be free of lumps before using.
 - b. Mortar Mixer
 - 1) Add 1.5 gal (5.7 L) of clean potable water for each 50 lb (22.7 kg) bag of Primus DM into a clean mortar mixer.
 - 2) Add the Primus DM while the mixer is running. Mix three to five (3 – 5) minutes, shut mixer off for five (5) minutes, then run mixer for another two to three (2 - 3) minutes to break the set and add a small amount of water if necessary to adjust the workability. The pot life is one to three (1-3) hours depending on weather.
 - 3. Genesis DM
 - a. Pail Mixing
 - 1) One bag of Genesis DM will produce approximately 5 gal (19 L) of Genesis DM mixture. To a clean 5 gal (19 L) pail, add 6 - 7 qt (5.7 - 6.6 L) of clean potable water.
 - 2) Add the Genesis DM slowly while constantly mixing with a “Twister” paddle or equivalent mixing blade, powered by a 1/2 in (12.7 mm) drill, at 500 - 1200 rpm. **NOTE: A minimum 7 amp drill works best for Portland cement based materials.**
 - 3) Thoroughly mix until uniformly wetted, adjusting consistency with a small amount of water or Genesis DM.
 - 4) Let set for ten (10) minutes. Retemper, adding a small amount of water if necessary. Material must be free of lumps before using.

- 1) Add 6 - 7 qt (5.7 - 6.6 L) of clean potable water for each 50 lb (22.7 kg) bag of Genesis DM into a clean mortar mixer.
 - 2) Add the Genesis DM while the mixer is running. Mix three to five (3 – 5) minutes, shut the mixer off for ten (10) minutes, then run mixer for another two to three (2 – 3) minutes to break the set adding a small amount of water if necessary to adjust workability. The pot life is one to one and one half (1 – 1 1/2) hours depending on weather.
4. Genesis DMS
- a. Sprayer
 - 1) Connect a source of clean, cool potable water to a spray machine suitable for EIFS applications.
 - 2) Regulate the water flow rate to provide the desirable mixing consistency of material. Material may thicken up upon leaving the mixing cylinder at a given water flow and loosen up after pumping.
NOTE: The consistency for application must be determined after pumping.
 - b. Pail Mixing
 - 1) One bag of Genesis DMS will produce approximately 5 gal (19 L) of Genesis DMS mixture. To a clean 5 gal (19 L) pail, add 7 - 9 qt (6.6 - 8.5 L) of clean, cool potable water.
 - 2) Add the Genesis DMS slowly while continuously mixing with a “Twister” paddle or equivalent mixing blade, powered by a 1/2 in (12.7 mm) drill, at 500 - 1200 rpm. **NOTE: A minimum 7 amp drill works best for Portland cement based materials.**
 - 3) Thoroughly mix until uniformly wetted, adjusting consistency with a small amount of water or Genesis DMS.
 - 4) Let set for five (5) minutes. Retemper, adding a small amount of water if necessary. Material must be free of lumps before using.
 - c. Mortar Mixer
 - 1) Add 7 - 9 qt (6.6 - 8.5 L) of clean, cool potable water for each 50 lb (22.7 kg) bag of Genesis DMS into a clean mortar mixer.
 - 2) Add the Genesis DMS while the mixer is running. Mix three to five (3 - 5) minutes, shut the mixer off for five (5) minutes, then run mixer for another two to three (2 - 3) minutes. Retemper, adding a small amount of water if necessary. Material must be free of lumps before using. The pot life is one to two (1 - 2) hours depending on weather.
5. Rapidry DM 35-50
- a. Pail Mixing
 - 1) One 50 lb (22.7 kg) bag of Rapidry DM 35-50 will produce approximately 5 gal (19 L) of Rapidry DM 35-50 mixture. To a clean Dryvit 5 gal (19 L) pail, add 6.5 qt (6.1 L) of clean potable water. As an alternative, on the inside of the Dryvit 5 gal (19 L) pail, draw a horizontal line which measures 4 7/16 in (113 mm) from the base of the pail and fill with water.
 - 2) Add the Rapidry DM 35-50 slowly while mixing with a “Twister” paddle or equivalent mixing blade, powered by a 1/2 in (12.7 mm) drill, at 500 - 1200 rpm. **NOTE: A minimum 7 amp drill works best for Portland cement based materials.**
 - 3) Thoroughly mix until uniformly wetted, adjusting consistency with a small amount of water or Rapidry DM 35-50 material. Material must be free of lumps before using.
 - b. Mortar Mixer
 - 1) Add 6.5 qt (6.1 L) of clean potable water for each 50 lb (22.7 kg) bag of Rapidry DM 35-50 into a clean mortar mixer.
 - 2) Add the Rapidry DM 35-50 while the mixer is running. Mix for 3 to 5 minutes adjusting consistency with a small amount of water or Rapidry DM 35-50. Material must be free of lumps before using. The pot life is approximately 30 minutes depending on temperature.
6. Rapidry DM 50-75
- a. Pail Mixing
 - 1) One 45 lb (20.4 kg) bag of Rapidry DM 50-75 will produce approximately 5 gal (19 L) of Rapidry DM 50-75 mixture. To a clean Dryvit 5 gal (19 L) pail, add 5.5 qt (5.2 L) of clean potable water. As an alternative, on the inside of the Dryvit 5 gal (19 L) pail, draw a horizontal line which measures 3 13/16 in (97 mm) from the base of the pail and fill with water.
 - 2) Add the Rapidry DM 50-75 slowly while mixing with a “Twister” paddle or equivalent mixing blade, powered by a 1/2 in (12.7 mm) drill, at 500 - 1200 rpm. **NOTE: A minimum 7 amp drill works best for Portland cement based materials.**
 - 3) Thoroughly mix until uniformly wetted, adjusting consistency with a small amount of water or Rapidry DM 50-75 material.
 - 4) Let set for 5 minutes. Retemper, adding a small amount of water if necessary. Material must be free of lumps before using.

- b. Mortar Mixer
 - 1) Add 5.5 qt (5.2 L) of clean potable water for each 45 lb (20.4 kg) bag of Rapidry DM 50-75 into a clean mortar mixer.
 - 2) Add the Rapidry DM 50-75 while the mixer is running. Mix for 3 to 5 minutes, shut the mixer off for 5 minutes, then run mixer for another 2 to 3 minutes to break the set adjusting consistency with a small amount of water or Rapidry DM 50-75. The pot life is approximately 30 minutes depending on temperature.
- D. Base Coat only
 - 1. NCB
 - a. Open the bucket with a utility knife or lid-off.
 - b. Mix NCB to a smooth, homogeneous consistency with a “Twister” paddle or equivalent mixing blade, powered by a 1/2 in (12.7 mm) drill, at 450 - 500 rpm. A small amount of clean potable water may be added to adjust workability.
 - 2. Dryflex
 - a. Open the bucket with a utility knife or lid-off.
 - b. Due to shipping and storage, there may be some separation of materials. Prior to splitting the material and adding Portland cement, mix the material thoroughly. Use a “Twister” paddle or equivalent mixing blade, powered by a 1/2 in (12.7 mm) drill, at 500 - 1200 rpm. **NOTE: A minimum 7 amp drill works best for Portland cement based materials. CAUTION: Do not over-mix or use other types of mixing blades as air entrapment and product damage may occur and result in workability and performance problems.**
 - c. Pour 1/2 of the freshly mixed material [approximately 22.5 lbs (10.21 kg)] into a clean plastic container.
 - d. Add 1/4 of a bag [approximately 22.5 lbs (10.21 kg)] of fresh, lump free Type I or II Portland cement. Either gray or white cement is acceptable. Add cement slowly and mix thoroughly. **Do not add large quantities of cement at one time.**
 - e. Clean potable water may be added to the mixture to adjust the workability. Add as little water as possible, in small increments, and only after the Portland cement is thoroughly mixed. **Do not over-water as this will degrade the performance of the Outsulation RMD System and promote efflorescence.**
NOTE: It is advisable to mix the Dryflex material with Portland cement thoroughly; then wait five (5) minutes and mix again to break the initial set. Retempering with a small amount of water is permissible provided the mixture has not set. The mixture has a pot life similar to any Portland cement material. Mix only as much material as can be conveniently used during a work period.
- E. Primers
 - 1. Color Prime™, Color Prime W™, Primer with Sand™, and Weatherprime®
 - a. Mix material with a “Twister” paddle or equivalent mixing blade, powered by a 1/2 in (12.7 mm) drill, at 450 - 500 rpm to a homogeneous consistency.
- F. Finish
 - 1. Quarzputz®, Quarzputz E, Sandblast®, Freestyle®, Sandpebble®, Sandpebble E, Sandpebble Fine, Sandpebble Fine E, HDP™ Finishes and Weatherlastic® finishes.
 - a. Thoroughly mix the factory-prepared Dryvit finish with a “Twister” paddle or equivalent mixing blade powered by a 1/2 in (12.7 mm) drill, at 450 - 500 rpm, until a uniform, homogeneous consistency is attained. A small amount of clean potable water may be added to adjust workability. Always add the same amount of water to each pail within a given lot to avoid color variation.

NOTE: If using a tint pack to color finish, please refer to Tint Pack Mixing Instructions, [DS750](#).
- G. Specialty Finishes
 - 1. Ameristone™
 - a. Mix Ameristone for approximately one (1) minute to ensure uniformity using a “Twister” paddle or equivalent mixing blade powered by a 1/2 in (12.7 mm) drill, at 450 - 500 rpm, just prior to application. **DO NOT OVERMIX.**
 - b. Mix all pails for the same amount of time.
 - c. If clean potable water is added as described in [DS142](#) for various application techniques, the same amount must be added to each pail.
 - 2. Stone Mist®
 - a. Mix Stone Mist for one (1) minute to ensure uniformity using a “Twister” paddle or equivalent mixing blade, powered by a 1/2 in (12.7 mm) drill, 450 - 500 rpm, just prior to application. **DO NOT OVERMIX.**
 - 3. TerraNeo®
 - a. Mix TerraNeo for one (1) minute just prior to application, to ensure uniformity using a “Twister” paddle or equivalent mixing blade, powered by a 1/2 in (12.7 mm) drill, at 450 - 500 rpm. **DO NOT OVERMIX.**

- 4. Custom Brick™ Finishes
 - a. For Custom Brick finishes, refer to Dryvit Custom Brick Application Instructions, [DS154](#), for complete mixing instructions.

NOTE: If using a tint pack to color specialty finishes, please refer to Tint Pack Mixing Instructions, [DS750](#).

H. Coatings and Sealers

- 1. Demandit Smooth and Demandit Sanded, HDP Water-Repellent Coating, Weathercoat™, and Weatherlastic Smooth
 - a. Mix material with a “Twister” paddle or equivalent mixing blade, powered by a 1/2 in (12.7 mm) drill, at 450 - 500 rpm to a homogeneous consistency.
- 2. Tuscan Glaze™
 - a. Mix Tuscan Glaze with a “Twister” paddle or equivalent mixing blade, powered by a 1/2 in (12.7 mm) drill, at 450 - 500 rpm to a homogeneous consistency. As an alternate, boxing of buckets is acceptable.
- 3. SealClear™
 - a. Stir material thoroughly before using and stir often during the application process. As an alternate, boxing of buckets is acceptable.

IV. Rough Opening Preparation Options

A. AquaFlash System option

- 1. AquaFlash must be installed to provide a continuous barrier from the water-resistive barrier/sheathing substrate onto the framing at discontinuities and terminations such as openings, expansion joints, tops of parapets, etc. Refer to Dryvit Outsulation RMD System Installation Details, [DS106](#).
- 2. Surface Preparation
 - a. The surface to receive the AquaFlash System must be clean, dry, smooth and free of any condition that will hinder adhesion.
 - b. Clean loose dust or dirt from the surface by wiping with a clean, dry cloth or brush.
- 3. AquaFlash System Application
 - a. Rough Openings (Windows, Doors, Others)
 - 1) Cut AquaFlash Mesh to proper length [rough opening plus 4 in (102 mm)] extending 2 in (51 mm) past each jamb – Figure 1.

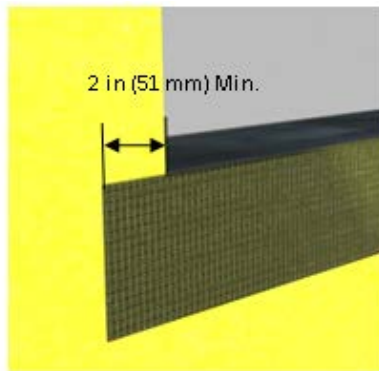

Figure 1

- 2) Begin at the sill of an opening. Using a brush or 3/4 in (19 mm) nap roller, apply a liberal coat of AquaFlash liquid material to the water-resistive barrier/substrate surface. **NOTE: The AquaFlash System must extend to the interior face of the wall opening.**
- 3) Immediately lay the AquaFlash Mesh into the wet material and brush smooth adding additional material to completely embed the mesh - Figure 2.

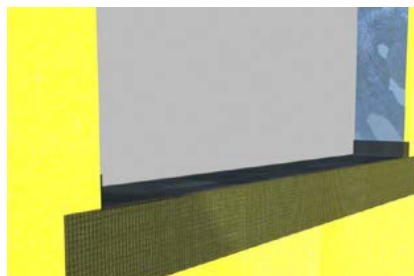

Figure 2

- 4) Install the AquaFlash System at the jambs in the same manner extending 2 in (51 mm) above the head and overlapping onto the sill material a minimum of 2 in (51 mm) – Figure 3.

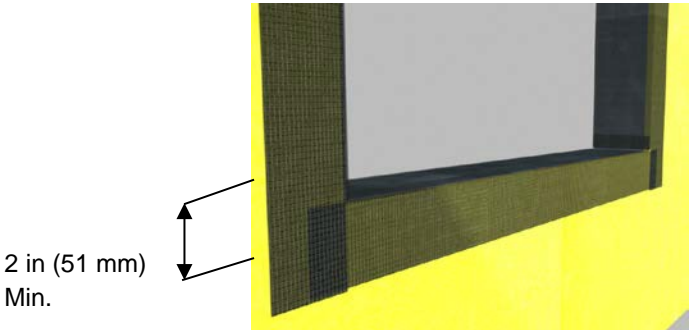

Figure 3

- 5) Install the AquaFlash System at the head overlapping the jamb pieces a minimum of 2 in (51 mm) – Figure 4.

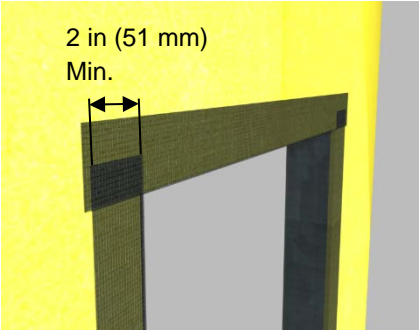

Figure 4

- 5a) As an alternative, preformed Dryvit AquaFlash Corners can be applied at each corner of the opening to reduce the number of field cuts required. The AquaFlash Corners are installed in the same manner as the AquaFlash Mesh. – Figure 5

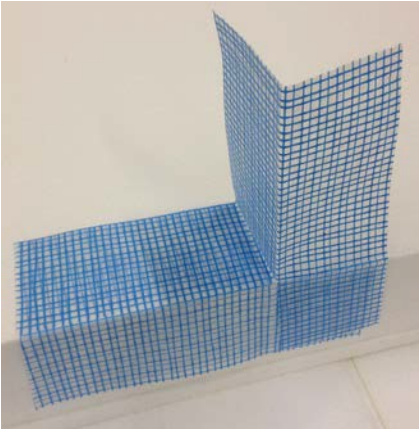

Figure 5

- 6) Install diagonal “butterflies” consisting of AquaFlash Liquid and AquaFlash Mesh at each sill/jamb corner – Figure 6.



Figure 6

- 7) Allow material to set for approximately 15 minutes then apply a second liberal coat of AquaFlash liquid and smooth out to ensure a continuous film free of voids, pinholes, or other discontinuities.

4. Sill Pan Flashing (Exposed)

- a. Install a watertight pan flashing at all sill locations - Figure 7.
- b. The flashing shall extend between the framing members of the rough opening and shall be sized to protect the sill, sheathing and the surface of the Outsulation RMD System. It must include vertical legs at the back and sides to ensure proper collection of water.

NOTE: All flashing shall be continuous, have watertight seams, and shall be configured to shed all water to the exterior of the system. Apply a strip of AquaFlash Mesh over the vertical legs of the pan flashing to seal the pan to the jambs.

- c. The flashing shall extend a minimum of 2 1/2 in (64 mm) down over the face of the Outsulation RMD System - Figure 7.

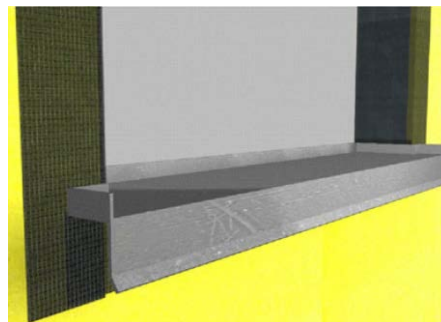

2 1/2 in
(64 mm) Min.

Figure 7

5. Sill Pan Flashing (Concealed) for use with nail-on-windows (refer to Dryvit Outsulation RMD Installation Details, [DS106](#))

- a. Install a watertight pan flashing at all sill locations.
- b. The flashing shall extend between the framing members of the rough opening and shall be sized to protect the sill and sheathing. It must include vertical legs at the back and sides to ensure proper collection of water. It shall extend a minimum of 4 in (102 mm) below the opening and have a sloped horizontal leg which continues over the top edge of the Outsulation RMD System.

NOTE: All flashing shall be continuous, have watertight seams, and shall be configured to shed all water to the exterior of the system. Apply a strip of AquaFlash Mesh over the vertical legs of the pan flashing to seal the pan to the jambs.

5. Installation of AquaFlash Over Metal or PVC Flashing Materials

- a. The AquaFlash System may be applied directly over clean galvanized, painted metal, or PVC flashing.
- b. Prepare rough opening as described in Section IV.A.3.
- c. Install flashing material per contract documents.
- d. Clean the surface of the flashing to ensure that it is free of dirt, dust, oil, or other contaminants that may interfere with adhesion. **NOTE: PVC products should be lightly abraded to break the surface skin and provide tooth for the coating.**

- e. Cut AquaFlash Mesh to proper length [flashing plus 4 in (102 mm) extending 2 in (51 mm) beyond each end of flashing] - Figure 8.

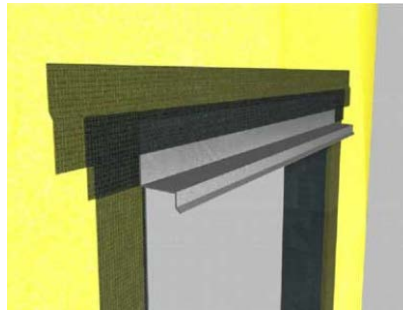

Figure 8

- f. Using a brush or 3/4 in (19 mm) nap roller, apply a liberal coat of AquaFlash Liquid material to the flashing and adjacent water-resistive barrier/substrate surface.
- g. Immediately lay the AquaFlash Mesh into the wet material and brush smooth adding additional material to completely embed the mesh.
- h. Allow material to set for 15 minutes then apply a second liberal coat of AquaFlash liquid and smooth out to ensure a continuous film free of voids, pinholes, or other discontinuities and allow to dry.

B. Dryvit Backstop NT option

1. Surface Preparation

- a. Apply only when air and surface temperatures are above 40 °F (4 °C).
- b. The surface to receive the Backstop NT must be clean, dry, smooth and free of any other condition that will hinder adhesion.
- c. Remove loose dust or dirt from the surface by wiping with a clean, dry cloth or brush.

2. Dryvit Backstop NT Application

NOTE: Backstop NT may be applied to the sill of the opening but it must also be covered with either the Dryvit AquaFlash System or Dryvit Flashing Tape.

a. Rough Openings (Windows, Doors, Others)

- 1) Apply Dryvit Grid Tape along the jambs and head of the opening as well as all sheathing joints that may intersect the opening and lap onto face of wall a minimum of 2 in (51 mm). Add additional pieces of Grid Tape at the inside corners (sill/jambs) of the opening to maintain continuity – Figure 9.

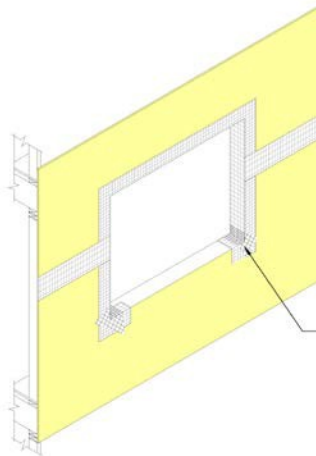

Figure 9

Apply Dryvit Grid Tape at corners

- 2) Using a stainless steel trowel apply Backstop NT – Texture over the Grid Tape extending to the inside face of the opening and onto the face of the exterior sheathing a minimum of 6 in (152 mm) – Figure 10.

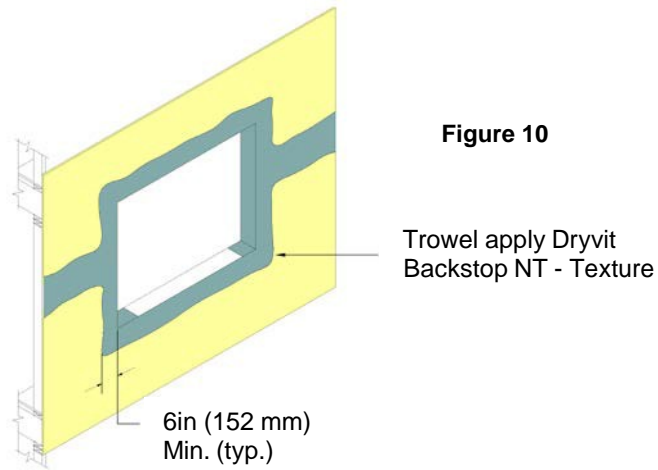

Figure 10

- 3) Apply Dryvit AquaFlash System or Flashing Tape at sill in accordance with Sections IV.A.3 and IV.C respectively. **NOTE: AquaFlash System or Flashing Tape must extend up the jambs a minimum of 4 in (102 mm) – Figure 11.**

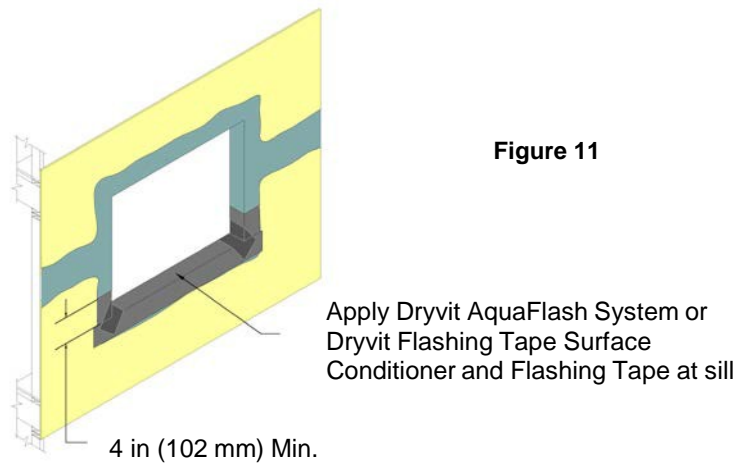

Figure 11

- 4) Install the specified component (i.e. window, etc.) and associated flashings per manufacturer's directions and contract documents. Then apply Backstop NT – Texture or Smooth to the remainder of the wall surface as described in Section VI and lap over the previously installed material (do not lap over Flashing Tape if specified) around openings – Figure 12.

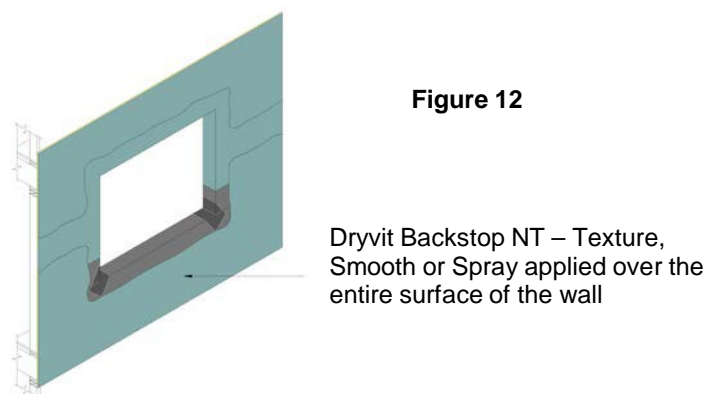

Figure 12

C. Dryvit Flashing Tape option

Caution: The Dryvit Flashing Tape and Surface Conditioner must be handled properly. Refer to the Safety Data Sheets for proper handling, storage, health and environmental considerations.

NOTE: When Dryvit Flashing Tape is specified for rough opening preparation the water-resistive barrier must be installed prior to preparing the opening (see Section VI).

NOTE: Coordinate the Dryvit Flashing Tape application with the insulation board installation. Apply only enough Dryvit Flashing Tape that can be covered with the insulation board in the same work period.

1. Dryvit Flashing Tape must be installed to provide a continuous barrier from the water-resistive barrier/sheathing substrate onto the framing edges at discontinuities and terminations such as openings, expansion joints, tops of parapets, etc. Refer to Dryvit Outsulation RMD System Installation Details, [DS106](#).
2. Surface Preparation
 - a. Apply only when air and surface temperatures are above 40 °F (4 °C).
 - b. The surface to receive the Dryvit Flashing Tape must be clean, dry, smooth and free of any condition that will hinder adhesion.
 - c. Clean loose dust or dirt from the surface by wiping with a clean, dry cloth or brush.
3. Dryvit Flashing Tape Surface Conditioner Application
 - a. Pour the desired amount of surface conditioner into a clean container to prevent contamination.
 - b. Apply to the surfaces, which are to receive the Dryvit Flashing Tape, using a brush or roller. Sufficient surface conditioner should be applied to condition the surface to a dust free state suitable for the application of the Dryvit Flashing Tape. It should not be applied so heavily that it puddles or runs. Application of excess material will not improve adhesion but will extend the drying time.
 - c. Allow to dry until the surface is slightly tacky. Low temperatures and high humidity conditions may require longer drying times. Conditioning should be limited to areas that can be covered with Dryvit Flashing Tape within the same day.
4. Dryvit Flashing Tape Application
 - a. General
 - 1) Cut the Dryvit Flashing Tape to the appropriate length. Peel the release paper to expose the rubberized asphalt adhesive and align the tape into position before touching the wall.
 - 2) Position the tape on the wall face so that it covers the Backstop NT 2 in (51 mm) and the remainder is turned into the opening.
 - 3) Move along the opening being careful to place the tape as evenly as possible and avoiding fish-mouths along the edges. If wrinkles develop, cut out the affected area and replace.
 - 4) Apply pressure to the tape so that it is firmly in contact with the wall surface. Press the tape into place with a hand roller as soon as possible to ensure continuous and intimate contact with the surface.
 - 5) End laps that occur must maintain a minimum overlap of 2 in (51 mm).
 - 6) Apply Dryvit Flashing Tape so that it completely covers the stud/track and extends to the interior face of the opening. Additional strips of Dryvit Flashing Tape may be needed.
 - 7) Cold weather application may require the use of a heat gun to warm the wall surface in order to obtain good initial adhesion.
 - b. Sill/jamb intersections and similar conditions
 - 1) Apply the Dryvit Flashing Tape as shown in the detail below - Figure 13.
 - 2) Apply sill piece first, then apply the corner splice piece. The jamb piece is applied next, lapping over the splice piece.

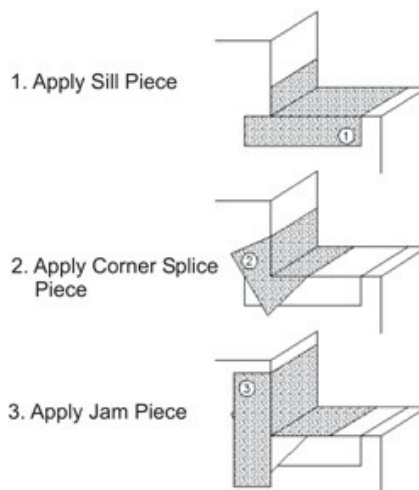

Figure 13

- c. Head/jamb intersections
 - 1) The jamb pieces are applied first, followed by the corner splice pieces. The head piece is applied last.
 - 2) Lap additional pieces of Dryvit Flashing Tape as necessary to cover the returns to the inside edge of the stud or track.

V. Substrate Expansion Joint Bridging Options

A. AquaFlash System

- 1. The width of the AquaFlash Mesh must overlap each side of the joint a minimum of 2 in (51 mm) - Figure 14.
- 2. Clean the joint to allow for the installation of a backer material. Install a closed cell polyethylene backer rod sized a minimum of 50% larger than the joint width. Install so that the backer rod is recessed or projects a minimum of 1/4 in (6.4 mm) from the wall surface.

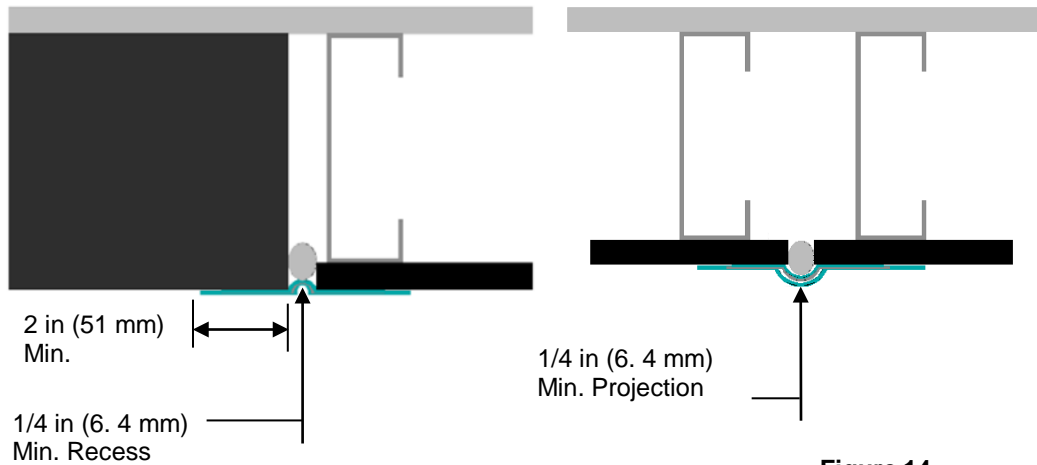

Figure 14

- 3. Using a brush or 3/4 in (19 mm) nap roller, apply a liberal coat of AquaFlash Liquid material to the backer rod and adjacent substrate surface to the width of the AquaFlash Mesh - Figure 15.

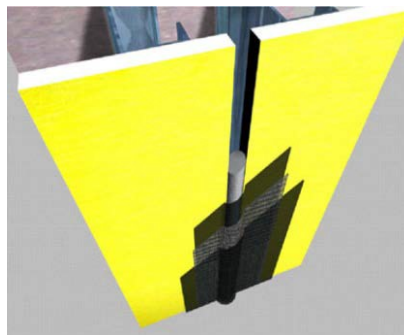

Figure 15

- 4. Immediately lay the AquaFlash Mesh into the wet material and brush smooth adding additional material to completely embed the mesh.
- 5. Allow material to set for 15 minutes then apply a second liberal coat of AquaFlash Liquid and smooth out to ensure a continuous film free of voids, pinholes, or other discontinuities.

B. Dryvit Flashing Tape and Flashing Tape Surface Conditioner

NOTE: When Dryvit Flashing Tape is specified for substrate expansion joint bridging, the air/water-resistant barrier must be installed prior to preparing the joint (see Section VI).

NOTE: Coordinate the Dryvit Flashing Tape application with the insulation board installation. Apply only enough Dryvit Flashing Tape that can be covered with the insulation board in the same work period.

- 1. Surface Preparation
 - a. Apply only when air and surface temperatures are from 40 °F (4 °C) minimum to 100 °F (38 °C) maximum.
 - b. The surface to receive Dryvit Flashing Tape Surface Conditioner and Dryvit Flashing Tape must be clean, dry, smooth and free of any condition that will hinder adhesion.
 - c. Clean loose dust or dirt from the surface by wiping with a clean, dry cloth or brush.

2. Dryvit Flashing Tape Surface Conditioner Application
 - a. Pour the desired amount of surface conditioner into a clean container to prevent contamination.
 - b. Apply to the surfaces, which are to receive the Dryvit Flashing Tape, using a brush or roller. Sufficient surface conditioner should be applied to condition the surface to a dust free state suitable for the application of the Dryvit Flashing Tape. It should not be applied so heavily that it puddles or runs. Application of excess material will not improve adhesion but will extend the drying time.
 - c. Allow to dry until the surface is slightly tacky. Low temperatures and high humidity conditions may require longer drying times. Conditioning should be limited to areas that can be covered with Dryvit Flashing Tape within the same day.
3. Position the Dryvit Flashing Tape so that it is centered over the joint. Adhere to one side of the joint, and then adhere the adjacent side. Allow enough slack in the tape to account for any joint movement.

VI. Air/Water-Resistive Barrier Application

- A. Two types of water-resistive barriers are acceptable for use with the Outsulation RMD System.
 1. Backstop NT liquid applied membrane (air/water-resistive barrier)
 2. Code compliant sheet type membranes (water-resistive barrier only)
- B. Backstop NT
 1. When using Backstop DMS refer to [DS704](#).
 2. Ensure that the wall surface and ambient temperature are above 40 °F (4 °C) minimum to 100 °F (38 °C) maximum at the time of Backstop NT application. **WARNING: Do not apply the Dryvit materials in the rain. The underlying wall materials and substrate surface must be dry prior to applying the air/water-resistive barrier.**
 2. Sheathing Substrates
 - a. Prior to applying the Backstop NT over a sheathing substrate, check to ensure that:
 - 1) The sheathing is of a type listed in the Outsulation RMD System Specification, [DS155](#).
 - 2) The sheathing is structurally sound, free of loose material, voids, projections or other conditions that may interfere with the installation of the Outsulation RMD System.
 - 3) The sheathing is clean, dry, and free of grease, oil, paint and other foreign material.
 - a) Exterior grade gypsum sheathing shall not show signs of deterioration and facer shall be firmly bonded to the core.
 - b) Plywood or OSB moisture content shall not exceed 19% as measured by a probe type moisture meter.
 - 4) There are no planar irregularities greater than 1/4 in (6.4 mm) within any 4 ft (1.2 m) radius.
SHEATHING WITH GAPS OR DAMAGE EXCEEDING 1/4 in (6.4 mm) IN ANY ONE DIRECTION MUST BE REPLACED. NOTE: Notify the general contractor and/or architect and/or owner of all discrepancies. Do not proceed until all unsatisfactory conditions have been corrected. NOTE: OSB sheathing requires that joints and fasteners be treated with Backstop NT – Texture. Two (2) coats of Backstop NT-Smooth or Backstop NT – Spray are required for the field of the wall. Backstop NT-Texture is not recommended for application in the field of the board.
 3. Concrete or Masonry Substrates
NOTE: Backstop NT – Texture or Backstop NT – Spray are recommended for use over concrete and masonry.
 - a. Prior to applying the Backstop NT - Texture or Backstop NT – Spray over a concrete or masonry substrate, check to ensure that:
 - 1) All cracks are repaired using appropriate procedures and materials.
 - 2) The substrate is structurally sound, free of loose material, voids, projections or other conditions that may interfere with the installation of the Outsulation RMD System.
 - 3) The substrate is clean, dry, free of grease, oil, paint, form release agents, efflorescence and other foreign materials that may inhibit adhesion.
 - 4) There are no planar irregularities greater than 1/4 in (6.4 mm) within any 4 ft (1.2 m) radius.
 - a) Mortar joints that are not struck flush or heavily textured masonry units shall be skim coated with Dryvit Genesis or Genesis DM prior to the application of Backstop NT – Texture or Backstop NT – Spray.
 - i Mix Genesis or Genesis DM in accordance with Section III.C.1 or III.C.3, respectively.
 - ii With a stainless steel trowel, apply a coat of the Genesis mixture or Genesis DM mixture over the substrate to fill the mortar joints and surface texture to provide a uniform smooth surface for the application of the Backstop NT Material.
 - iii Allow the skim coat to completely dry prior to applying the Backstop NT – Texture or Backstop NT – Spray.

4. Usage/Application Chart

Backstop NT (BSNT) - Texture, Smooth, and Spray Usage/Application Chart													
			Approx. Coverage Per Pail	Approx. Coverage Per Drum									
Exterior Grade Gypsum Sheathing													
Joints ^a	BSNT - Texture	Trowel	300 lin. ft (91 m)										
Face ^e	BSNT - Texture	Trowel, FoamPRO #58 Roller ^b or Texture Sprayer	250-300 ft ² (23-28 m ²)										
	BSNT - Smooth ^{c,g}	1/2 in (12.7 mm) Nap Roller or Texture Sprayer	500 ft ² (46 m ²)										
	BSNT - Spray ⁱ	Airless Spray	500-600 ft ² (46-56 m ²)	5,000-6,000 ft ² (465-557 m ²)									
Fiberglass Faced Exterior Gypsum Sheathing													
Joints ^a	BSNT - Texture	Trowel	300 lin. ft (91 m)										
Face ^e	BSNT - Texture	Trowel or Texture Sprayer	250-300 ft ² (23-28 m ²) [includes joints]										
	BSNT - Smooth ^{c,g}	3/4 in (19 mm) Nap Roller or Texture	400 ft ² (37 m ²)										
	BSNT - Spray ^g	Airless Spray	500-600 ft ² (46-56 m ²)	5,000-6,000 ft ² (465-557 m ²)									
Exposure 1, Exterior Grade, and Fire Retardant Treated Plywood; and Exterior Cement Board													
Joints ^a	BSNT - Texture	Trowel	300 lin. ft (91 m)										
Face ^e	BSNT - Texture	Trowel, FoamPRO #58 Roller ^b or Texture Sprayer	250-300 ft ² (23-28 m ²)										
	BSNT - Smooth ^{c,g}	1/2 in (12.7 mm) Nap Roller or Texture Sprayer	400 ft ² (37 m ²)										
	BSNT - Spray ^g	Airless Spray	500-600 ft ² (46-56 m ²)	5,000-6,000 ft ² (465-557 m ²)									
APA Exposure 1 Rated Oriented Strand Board (OSB)													
Joints ^a	BSNT - Texture	Trowel	300 lin. ft (91 m)										
Face ^e	BSNT - Smooth ^g	1/2 in (12.7 mm) Nap Roller or Texture Sprayer	350-400 ft ² (33-37 m ²), applied in 2 coats, backrolled	3,500-4,000 ft ² (325-372 m ²)									
	BSNT - Spray ^g	Airless Spray											
Concrete and Masonry ^{d,g}													
Face	BSNT - Texture	Trowel ^f	200-250 ft ² (19-23 m ²) ^f applied in 1 coat										
	BSNT - Texture	FoamPRO #58 Roller or Texture Sprayer	200-250 ft ² (19-23 m ²) ^f applied in 2 coats, backrolled										
	BSNT - Spray ^g	Airless Spray	300-500 ft (28-46 m ²)	3,000-5,000 ft (279-465 m ²)									
<p>^a Tape the joints with Dryvit Grid Tape prior to application of Backstop NT - Texture at joints and screw heads.</p> <p>^b Up to 1 pint (16 oz) of water may be added to a 60 lb pail of Backstop NT - Texture for roller or spray applications only. The FoamPRO #58 roller cover (FoamPRO Mfg., Inc., www.foampromfg.com) is available at home supply stores.</p> <p>^c Because of application methodology and absorptive surface differences, two coats may be required to obtain this coverage.</p> <p>^d Due to variations in types of concrete/masonry, apply a 6 ft x 6 ft test area with coverage as indicated in the chart, before proceeding with the entire job. If there are voids in the substrate, particularly at the mortar joints, the job should be parged with Genesis[®], 24 hours prior to BSNT - Texture application. Backstop NT shall NOT be used as a skim coat for parging CMU joints or heavy textured units.</p> <p>^e Backstop NT - Texture (with up to 1 pint water addition per 60 lb. pail) or Smooth may be sprayed and backtrowelled/backrolled.</p> <p>^f Coverage may vary depending on the texture and porosity of the substrate. Coverage assumes a smooth, dense surface.</p> <p>^g Backstop NT should be applied at the recommended coverage rates to form a continuous film free of voids, pinholes or other discontinuities. The following approximate mil thicknesses are recommended:</p> <table border="0"> <tr> <td>Backstop NT Texture</td> <td>12 DFT</td> <td>20* WFT</td> </tr> <tr> <td>Backstop NT Smooth</td> <td>12 DFT</td> <td>20* WFT</td> </tr> <tr> <td>Backstop NT Spray</td> <td>9 DFT</td> <td>15* WFT</td> </tr> </table> <p>*Based on volume solids</p>					Backstop NT Texture	12 DFT	20* WFT	Backstop NT Smooth	12 DFT	20* WFT	Backstop NT Spray	9 DFT	15* WFT
Backstop NT Texture	12 DFT	20* WFT											
Backstop NT Smooth	12 DFT	20* WFT											
Backstop NT Spray	9 DFT	15* WFT											
<i>Refer to Product Data Sheets for Complete Mixing and Application Instructions</i>													

5. Application of Backstop NT

- a. Dryvit Grid Tape (not required with concrete and masonry substrates)
 - 1) For sheathing substrates, apply the Dryvit Grid Tape along all joints in the sheathing, as well as inside corners, outside corners, and exposed edges at terminations that will not be covered with Dryvit AquaFlash or Dryvit Flashing Tape.
 - 2) Center the Dryvit Grid Tape on the sheathing joints, edges, etc. with the pressure sensitive adhesive backing in contact with the sheathing surface. Press into position with hand pressure until adhesion is achieved.
 - 3) Apply only enough Dryvit Grid Tape as can be covered with Backstop NT - Texture in the same day.
- b. Dryvit Backstop NT - Texture Application
 - 1) General: Backstop NT - Texture can be applied using a roller, trowel or spray equipment over the approved substrates, as noted in the usage chart above. Backstop NT - Texture should be applied at the recommended coverage rate to achieve a continuous film at a dry film thickness of approximately 12 mils (0.3 mm).
 - 2) Roller Application
 - a) Apply Dryvit Grid Tape as described in Section VI.B.5.a above. Mix the Backstop NT - Texture material as described in Section III.B.2. Using a stainless steel trowel or spatula, apply a layer of Backstop NT - Texture over the Dryvit Grid Tape and spot all fastener heads – Figure 16.

NOTE: Dryvit Grid Tape is not necessary over fastener heads.

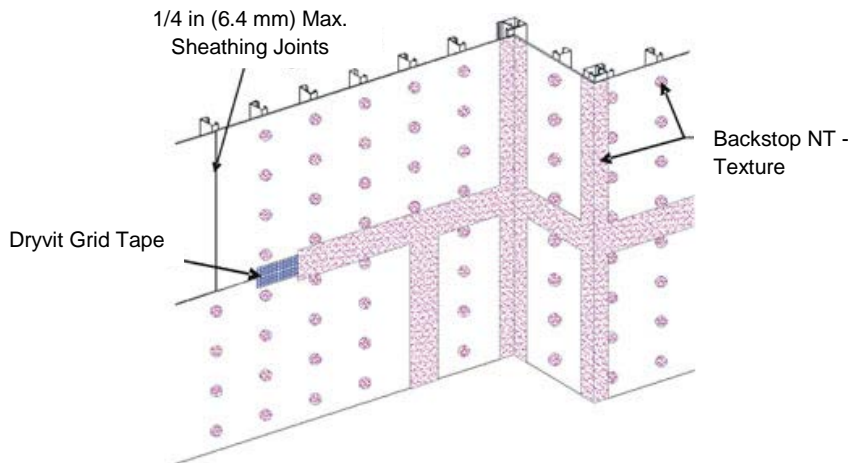

- b) Allow to dry for a minimum of 2 hour or until dry to the touch.

NOTE: Cool, humid conditions may require longer drying times.

- i) Because of the absorption characteristics, plywood substrates may require a second pass to fill any voids at the sheathing joints. After the first pass has dried, check the joints and spot any voids that may be present with additional Backstop NT – Texture material and allow to dry.
- c) Use a coarse, open-cell foam roller cover with a 3/8 in (10 mm) foam nap (FoamPRO roller #58). Apply a uniform, continuous film of Backstop NT – Texture over the entire surface of the sheathing, concrete or masonry, including the previously treated areas – Figure 17. **NOTE: If the roller pulls material back out of the sheathing joints, it indicates that the joint material is not sufficiently dry.**

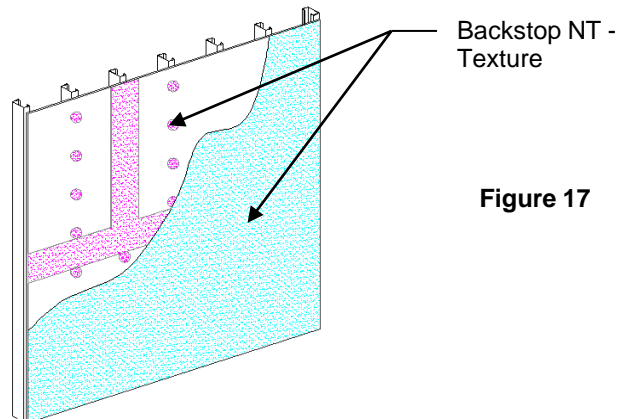

Figure 17

- i For concrete and masonry, ensure that a continuous film of uniform thickness is applied across the entire surface and across mortar joints. Minimum 2 coats are required allowing a minimum of 2 hours between coats. Cool, damp weather may require longer time between coats.
- d) While the Backstop NT - Texture is still wet, using a trowel or spatula, smooth out the Backstop NT - Texture around all window and door perimeters and other areas that will later receive Dryvit Flashing Tape - Figure 18.

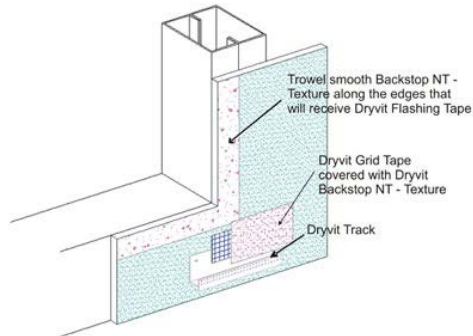

Figure 18

- e) The Backstop NT - Texture material should be applied in a uniform, continuous film at the recommended coverage rate. **NOTE: Substrates with a surface texture or high porosity will require additional material.**
- 3) Trowel Application
- a) Apply Dryvit Grid Tape as described in Section VI.B.5.a above. Mix the material, as described in Section III.B.2, and using a stainless steel trowel or spatula, apply a layer of Backstop NT – Texture over the grid tape. Spotting of fasteners is not necessary when applying Backstop NT - Texture using a trowel. Allow to dry for a minimum of 2 hour or until dry to the touch.
 - b) Using a stainless steel trowel, apply a continuous coating of Backstop NT - Texture material onto the entire surface. The material should be applied at a smooth, uniform, continuous film approximately equal to the thickness of the aggregate.
- 4) Spray/Back-Rolling Application
- a) Apply Dryvit Grid Tape as described in Section VI.B.5.a above. Mix the material as described in Section III.B.2 and using a stainless steel trowel or spatula, apply a layer of Backstop NT - Texture over the grid tape and spot all fastener heads. Allow to dry for a minimum of 2 hour or until dry to the touch. **NOTE: Cool, humid conditions may require longer drying times.**
 - b) Because of the absorption characteristics, plywood substrates may require a second pass to fill any voids at the sheathing joints. After the first pass has dried, check the joints and spot any voids that may be present with additional Backstop NT - Texture material and allow to dry.
 - c) Using a hand held hopper gun or other suitable spray equipment; spray a layer of Backstop NT - Texture onto the wall surface. Using a coarse, open-cell foam roller cover with a 3/8 in (9.5 mm) foam nap, roll the material to create a smooth continuous film. **NOTE: If the roller pulls material back out of the sheathing joints, it indicates that the joint material is not sufficiently dry.**
 - d) While Backstop NT - Texture is still wet, using a trowel or spatula, smooth out the Backstop NT - Texture around all window and door perimeters and other areas that will later receive Dryvit Flashing Tape – Figure 18.
 - e) Backstop NT - Texture material should be applied in a uniform, continuous film at the recommended coverage rate. **NOTE: Substrates with a surface texture or high porosity will require additional material.**
- 5) Allow the Backstop NT – Texture to completely dry prior to installation of the Outsulation RMD System.
- c. Dryvit Backstop NT - Smooth Application
- 1) General: Dryvit Backstop NT - Smooth can be applied using a roller or sprayed and back-rolled over the acceptable sheathing substrates. **NOTE: OSB sheathing requires that joints and fasteners be treated with Backstop NT – Texture. Two (2) coats of Backstop NT-Smooth or Backstop NT – Spray are required for the field of the wall. Backstop NT Texture is not recommended for application in the field of the board.**

- 2) Sheathing Substrates: If roller or spray equipment is used, all fastener heads shall be spotted and joints treated with Backstop NT - Texture and Dryvit Grid Tape prior to Backstop NT -Smooth application, in accordance with Section VI.B.5.b.
- 3) Roller Application
 - a) Using the appropriate nap roller (see Usage Application Chart), apply the Backstop NT - Smooth over the entire wall surface, including previously treated joints. **NOTE: If the roller pulls material back out of the sheathing joints, it indicates that the joint material is not sufficiently dry.**
 - b) Backstop NT - Smooth material should be applied in a uniform, continuous film at the recommended coverage rate – Figure 19. **NOTE: Sheathing substrates with a surface texture or high porosity will require additional material.**

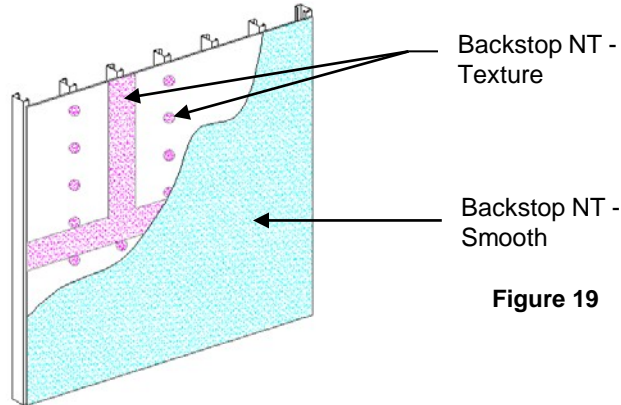

Figure 19

- 4) Spray/Back-rolling Application
 - a) Backstop NT - Smooth may be applied to the wall using a hopper gun or texture spray equipment and back-rolled using the appropriate nap roller (see Usage/Application Chart).
 - b) Allow the Backstop NT – Smooth to completely dry. Check the wall to ensure that the Backstop NT - Smooth is continuous and touch up any visible voids with additional Backstop NT - Smooth material.
- 5) Allow the Backstop NT – Smooth to completely dry prior to installation of the Outsulation RMD System.
- d. Backstop NT - Spray Application
 - 1) General: Dryvit Backstop NT - Spray can be applied using appropriate spray equipment over the acceptable sheathing substrates.
 - a) Airless spray equipment must be capable of providing minimum 3000 psi and minimum material flow of 1 gallon per minute with a minimum .021 spray tip. **NOTE: OSB sheathing requires that joints and fasteners be treated with Backstop NT – Texture. Two (2) coats of Backstop NT – Spray are required for the field of the wall. Backstop NT Texture is not recommended for application in the field of the board.**
 - b) Sheathing Substrates: All fastener heads shall be spotted, and joints treated with Backstop NT - Texture and Dryvit Grid Tape in accordance with Section VI.F.1 prior to Backstop NT - Spray application.
 - 1) Backstop NT - Spray material should be applied in a uniform, continuous film at the recommended coverage rate free of voids and pinholes – Figure 20. **NOTE: Sheathing substrates with a surface texture or high porosity will require additional material.**

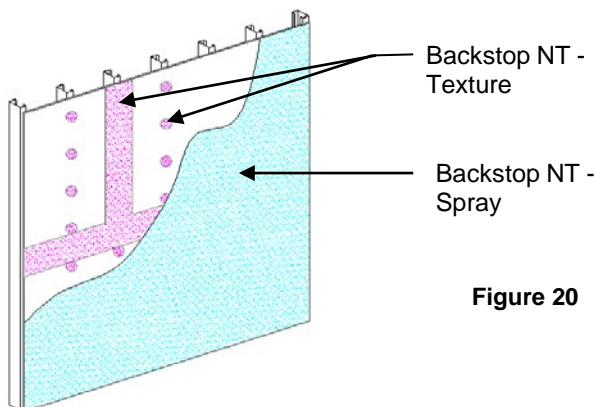

Figure 20

- e. Concrete/Masonry Substrates
 - 1) Backstop NT - Spray may be applied to the wall using appropriate airless spray equipment and back-rolled using the appropriate nap roller (see Usage Application Chart).
 - 2) Allow the Backstop NT - Spray to completely dry, check the wall to ensure that the Backstop NT - Spray is continuous and touch up any visible voids with additional material.
 - 3) Allow the Backstop NT - Spray to completely dry prior to installation of the Dryvit EIF system.

C. Sheet Membranes

1. Install sheet type membrane in a weather board fashion and in accordance with the manufacturer's instructions.

VII. Accessories and Drainage Options

A. Accessories

1. Installation of the Dryvit Drainage Strip or Drainage Track

a. Dryvit Drainage Strip (Optional - not required when Drainage Track is specified)

- 1) Dryvit Drainage Strip shall be used at the base of the walls and shall be installed at the heads of all penetrations and at horizontal expansion/control joints as shown in Outsulation RMD Installation Details, [DS106](#).
- 2) Using a chalk line, strike a level line at the base of the wall, head of opening or expansion/control joint to use as reference in applying the Dryvit Drainage Strip.
- 3) Install the Dryvit Drainage Strip by applying dabs of Dryvit's AP Adhesive at 12 in (300 mm) on center on the dry Backstop NT air/water-resistive barrier.
- 4) Position the Dryvit Drainage Strip along the chalk line and press firmly against the substrate to ensure firm contact between the adhesive and the wall surface. Staples or other fasteners may be used if necessary to maintain position until the adhesive sets.

b. Dryvit Drainage Track (Optional - not required when Drainage Strip is specified)

- 1) UV treated PVC perforated "J" channel with weep holes, complying with ASTM D 1784 and ASTM C 1063. Shall be one of the following:
 - a) Starter Trac STWP - without drip edge by Plastic Components, Inc.
 - b) Starter Trac STDE - with drip edge by Plastic Components, Inc.
 - c) Universal Starter Track by Wind-lock Corporation
 - d) Sloped Starter Strip with Drip by Vinyl Corp.
- 2) Dryvit Drainage Track may be used at the base of the wall and heads of openings. **NOTE: If project is defined as noncombustible, Drainage Track is limited to the base of the wall at finished grade level only.**
- 3) Using a chalk line, strike a level line at the base of the wall that coincides with either the top or bottom of the nailing flange.
- 4) Install the Dryvit Drainage Track by applying a continuous bead of Dryvit's AP Adhesive on the wall side of the track's nailing flange.
- 5) Position the track along the chalk line and press firmly against the substrate to ensure firm and continuous contact between the adhesive and the wall surface. **NOTE: Do not overlap tracks, they shall be butted tightly.**
- 6) Secure the track to the wall using corrosion resistant fasteners attached into the underlying framing members. **NOTE: It is recommended that the surface of the drainage track be lightly sanded to improve adhesion of Backstop NT or AquaFlash.**
- 7) Install the AquaFlash System, Backstop NT and Grid Tape or Flashing Tape on the flange of the Drainage Track and the adjacent wall in order to ensure water-tightness at the flange/wall interface. See Section IV for proper application.

B. Mechanical Fasteners for Securing Insulation Board (Systems 1, 2, 3)

1. Washer: A 2 in (51 mm) diameter polypropylene plastic plate with a recessed chamber and key openings for base coat penetration. The following washers are acceptable:
 - a. Wind-lock Wind-Devil 2 plates
 - b. ITW Buildex Gridmate PB and Grid-Master washers
2. Fasteners
 - a. Wood and Light Gauge Metal (20-26 ga) substrates.
 - 1) Shall be minimum No. 6 s-point bugle head corrosion resistant screws.
 - 2) The screws shall be of sufficient length to penetrate the wood substrates a minimum of 3/4 in (19 mm), and metal a minimum of 3/8 in (9.5 mm).
 - b. Light Gauge Steel Framing (16-20 ga)
 - 1) Shall be minimum No. 6 self drilling bugle head corrosion resistant screws.
 - 2) The screws shall be of sufficient length to penetrate the steel framing a minimum of 3/8 in (9.5 mm).

- c. Brick, Block and Concrete
 - 1) Anchors shall be a minimum 3/16 in (4.8 mm) diameter and corrosion resistant.
 - 2) Anchors shall be of sufficient length to penetrate the substrate a minimum of 1 in (25 mm). Pre-drilling a pilot hole 1/2 in (12.7 mm) deeper than the anchor embedment is necessary.

C. Drainage Options

1. Dryvit Drainage Mat

- a. Prior to applying the Dryvit Drainage Mat ensure that the water-resistive barrier complies with the code and has been installed in accordance with the manufacturer’s installation instructions.
- b. The Dryvit Drainage Mat is available in rolls 250 ft (76.2 m) long by 39 in (991 mm) wide and is colored blue for product identification. Ensure that the material is undamaged and clearly labeled with the Dryvit name.
- c. **Install the Drainage Mat over the water-resistive barrier with the corrugated “V” pattern oriented vertically. The “V” pattern runs parallel with the length of the roll.**
- d. Using a sharp utility knife or scissors, cut the mat to a workable length and position vertically on the wall. **NOTE: Install the mat so that it extends 1 in (51 mm) below the bottom edge of the sheathing substrate along the base of horizontal terminations.**
- e. Fasten in place using 3/8 - 1/2 in (9.5 - 12.7 mm) corrosion resistant staples or roofing nails spaced 12 in (305 mm) vertically by 16 in (400 mm) horizontally.
- f. To minimize bulging on the wall, install the Drainage Mat with slight tension [approximately 10 lbs (4.5 kg)] as it is being fastened. The mat should be extended approximately 4 in (102 mm) for every 10 ft (3 m) of length. This will ensure that the mat will lay flat and minimize bulging.
- g. Continue until the entire wall being worked is covered. Adjacent pieces are abutted and cut along each corner. Do not lap the pieces or try to fold mat around a corner.
- h. Only apply enough mat that can be covered with EPS insulation board during the same day or work period.

2. Tyvek StuccoWrap

- a. Using a sharp utility knife or scissors, cut the StuccoWrap to a workable length and position horizontally on the wall so that the built in wrinkles run up and down (vertically) for drainage. **NOTE: Extend the StuccoWrap so that it extends 1 in (51 mm) below the bottom edge of the sheathing substrate along the base of horizontal terminations.**
- b. Ensure that the StuccoWrap is installed over the sheathing in accordance with the manufacturer's instructions. Verify that the upper courses are properly lapped over the lower courses.
- c. Verify that terminations at windows, doors, and other openings are properly lapped and flashed as shown in the Dryvit Outsulation RMD System Installation Details, [DS106](#) and Dupont Tyvek Installation Instructions.
- d. The Dryvit Drainage Strip is required at terminations along the base of the System when StuccoWrap is used without the Drainage Track.

3. Grooved Insulation Board

- a. Insulation board is secured over the water-resistive barrier with acceptable mechanical fasteners (see section VII.B.1). Mechanical fasteners consist of a polypropylene washer used in conjunction with a corrosion resistant fastener.

4. Notched Trowel Adhesive Application

- a. Shall only be used when Backstop NT is used as the water-resistive barrier.
- b. Refer to Section VIII.D for proper method of applying the adhesive to the insulation board. Apply the adhesive so that the ribbons run vertically when the insulation board is placed on the wall.

5. Expanded Metal Lath

- a. The lath shall be galvanized, self-furred, diamond mesh lath installed over the water-resistive barrier in accordance with ASTM C 1063 except that the edges are abutted (not lapped). Lath seams that are not securely fastened to the substrate shall be wire tied.
- b. 2.5 lb/sq yd and 3.4 lb/sq yd lath is acceptable.

VIII. Insulation Board Installation

A. Inspection of Insulation Board

- 1. Insulation board shipped in a clear polyethylene bag bearing the Dryvit name. The lot number of the insulation shall be visible on the outside of the bag. Insulation board shall be obtained from Dryvit Systems, Inc. or its authorized distributors, and made exclusively by manufacturers licensed by Dryvit Systems, Inc.
- 2. One edge of each board shall bear the words Dryvit Outsulation RMD System, the plant identification number of the block molder, the appropriate model code report number, and the name of the third party quality control agency with corresponding number. In addition, one board in each bag shall bear the same markings on each face.
- 3. The insulation board shall measure maximum 2 ft (.6 m) by 4 ft (1.2 m).

4. Insulation board meets the following tolerances:
 - a. Length: Plus or minus 1/16 in (1.6 mm)
 - b. Width: Plus or minus 1/16 in (1.6 mm)
 - c. Thickness: Plus or minus 1/16 in (1.6 mm). Minimum thickness shall be 1 in (25 mm).
 - d. Squareness: Shall not deviate from square by more than 1/32 in (.75 mm) in 12 in (305 mm) of total length and width.
 - e. Edge Trueness: Shall not deviate more than 1/32 in (.75 mm) in 12 in (305 mm).
 - f. Face Flatness: Shall not exhibit any bowing of more than 1/32 in (.75 mm) in total length.

WARNING: Any Insulation Board not meeting the above requirements should be rejected and not installed.

B. Preparation at Terminations

1. Wrapping (also referred to as back wrapping)
 - a. When Drainage Mat is used as the drainage medium: Using tape, mask off the Drainage Mat that extends below the system to keep it free of base coat material (this will be trimmed off after system installation).
 - b. Apply a strip of Dryvit Detail Mesh over the Drainage Mat or Tyvek StuccoWrap along the horizontal terminations and staple to the substrate using corrosion resistant staples. Fasten at approximately 12 in (305 mm) on center into the substrate to maintain position. Position the mesh so that a minimum of 2 1/2 in (64 mm) extends onto the face of the insulation board.
 - c. Attach Detail Mesh around the perimeter of all openings, penetrations, and other system terminations in the same manner.
2. Drainage Track (Optional)
 - a. Drainage Track may be used in lieu of back wrapping along the base of the walls and heads of openings. When used, the Tyvek StuccoWrap, or water-resistive barrier and Drainage Mat are installed so that they lap into the track. The back edge of the EPS insulation shall be notched to accommodate the added thickness.

C. Mechanical Fastener Attachment (Systems 1, 2, 3)

1. Begin installation of the insulation board from a permanent or temporary support.

NOTE: If the vinyl drainage track is used, the insulation board is installed so that the bottom edge slips inside the track.
2. Beginning at the base of the wall use a 12 in (305 mm) by 4 ft (1.2 m) piece of insulation board as a starter row to minimize insulation board joints coinciding with sheathing board joints. **NOTE: The insulation board joints shall be offset from the sheathing joints a minimum of 8 in (203 mm).** Install the insulation boards with their long edges oriented horizontally.
3. Secure the insulation board to the framing or structural substrate with the appropriate fastener and washer. First install fasteners in the field of the insulation board, then follow with those along the insulation board edges. This will minimize shifting of the boards resulting in gaps between boards. Refer to Outsulation RMD Specification, [DS155](#) for specific fasteners to be used.
4. Refer to the Dryvit Outsulation RMD System Installation Details, [DS106](#), for proper fastening pattern. Install fasteners so that the face of the washer is flush or recessed a maximum of 1/16 in (1.6 mm) below the surface of the insulation board causing a slight dimple at each fastener location.
5. Install subsequent rows of insulation board in a running bond pattern with vertical joints staggered. A 16 (406 mm) offset is suggested to coincide with the repeating pattern of the fasteners.
6. With factory edges exposed, stagger vertical joints at inside and outside corners. Make sure corners are straight and plumb. Apply fasteners spaced every 12 in (305 mm) along inside and outside corners and along system terminations.

D. Adhesive Attachment (Systems 4, 5)

1. Mix the adhesive as described in Section III.C. **Warning: Do not apply Dryvit materials in the rain.**
2. Begin installation of the insulation board from a permanent or temporary support.

NOTE: If the vinyl drainage track is used, the insulation board is installed so that the bottom edge slips inside the track.
3. Beginning at the base of the wall, use a 12 in (305 mm) by 4 ft (1.2 m) piece of insulation board as a starter row to minimize insulation board joints coinciding with sheathing joints or metal lath joints. **NOTE: The insulation board joints shall be offset from the sheathing joints a minimum of 8 in (203 mm).** Install the insulation boards with their long dimension oriented horizontally.
 - a. Butter the edge of the insulation board at all terminations with adhesive in order to properly embed the previously installed Detail Mesh used for back wrapping. Back wrapping is necessary to provide the proper surface for application of sealant. **NOTE: The application of the adhesive mixture to the edge of the insulation board is only done when wrapping with the Detail Mesh.**
4. With a notched trowel, 3/8 in (9.5 mm) wide, 1/2 in (12.7 mm) deep notches spaced 1 1/2 in (38 mm) apart, apply the adhesive mixture to the backside of the insulation board. Holding the trowel at a 45° angle, apply firm pressure to the insulation board in order to scrape the excess adhesive from between the adhesive

ribbons. **NOTE: Apply the adhesive so that the ribbons run vertically (up and down) when the insulation board is placed on the wall to allow for drainage.**

5. Place in position on the wall and apply firm pressure over the entire surface of the insulation board to ensure uniform contact and high initial grab.
 6. Using a margin trowel, clean the insulation board edges of any adhesive mixture. Ensure that the insulation joints are abutted tightly and the surface is level and flush with adjacent boards.
 7. Install subsequent rows of insulation in a running bond pattern with vertical joints staggered.
 8. With factory edges exposed, stagger vertical joints at inside and outside corners. Make sure corners are straight and plumb.
- E. Windows, Doors, Mechanical Equipment and all Wall Penetrations
1. Corners of Wall Penetrations
 - a. Because insulation board joints cannot align with corners of openings, first cut L-shaped pieces of insulation board for the corners of the opening. Then measure and cut the insulation board to the proper length to fit between the corner pieces over the opening.
 - 1) Insulation board at heads of openings shall be notched when J track is specified as shown in the Dryvit Outsulation RMD System Installation Details, [DS106](#).
 2. Wrapping Openings
 - a. Attach Detail Mesh around the perimeter of the opening as described in Section VIII.B.1.b)
 - b. Hold the insulation board back from the window/door frame or mechanical equipment to allow for differential movement, proper system edge preparation, and sealant installation as shown in the Dryvit Outsulation RMD System Installation Details, [DS106](#).
 3. J-Track options - Installation of J-Track at heads of all openings [length not to exceed 20 ft (6 m)]

Tip: It is recommended to use a 3/4 in (19 mm) casing bead as manufactured by Plastic Components – item numbers 1075 or CB-75-25.

 - a. Insulation board shall be notched to receive J-track as shown in the Dryvit Outsulation RMD System Installation Details, [DS106](#).
 - b. Measure and cut J-Track so that it extends 6 in (152 mm) beyond the edges of the opening as shown in Outsulation RMD Installation Details [DS106](#).
 - c. Install the J-Track by applying a continuous bead of Dryvit AP Adhesive on the wall side of the vertical nailing flange of the track and position over the notched insulation board. Press firmly against the substrate to ensure firm and continuous contact between the adhesive and the wall surface.
 - d. Secure the track to the wall using corrosion resistant fasteners attached into the underlying framing members. **NOTE: It is recommended that the surface of the track be lightly sanded to improve adhesion.**
 - e. Install the AquaFlash System, Backstop NT and Grid Tape or Flashing Tape on the flange of the J-Track and the adjacent wall in order to ensure water-tightness at the flange/wall interface. See Section IV for proper application.
 4. Corners of all openings such as windows, doors, mechanical equipment and all penetrations shall be reinforced with Detail Mesh placed diagonally to the opening as illustrated in Figure 21.

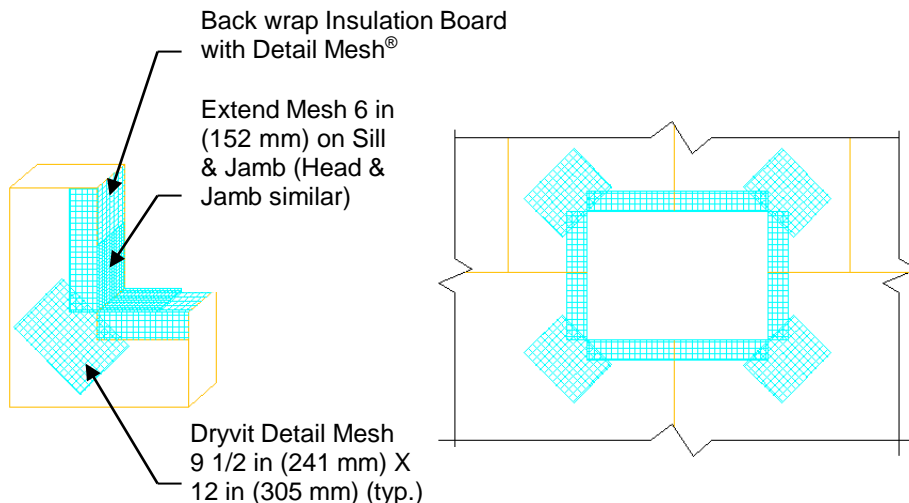

Figure 21

F. Expansion Joints

1. Attach Detail Mesh around the perimeter of the opening as described in Section VIII.B.1.b).
2. When abutting dissimilar materials, leave a minimum 3/4 in (19 mm) separation between the insulation board and abutting material to allow for differential movement, proper system edge preparation and sealant installation.
3. When the Outsulation RMD System is installed at a substrate transition, leave a minimum 3/4 in (19 mm) separation between the insulation boards to allow for differential movement, proper system edge preparation and sealant installation.

G. Slivering

1. If for any reason the insulation board joints are not butted tightly, slivers of insulation board must be installed to fill any gaps. ALL GAPS GREATER THAN 1/16 in (1.6 mm) MUST BE SLIVERED. **Tip: In order to create a tight fit, it is recommended that a wider joint be cut with a hot groover or similar tool to allow for a more precise fitting sliver. Do not install adhesive on sliver edges.**

H. Aesthetic Reveals

1. To install an aesthetic reveal, snap a straight line using a chalk line to mark the location.
2. Position a straight edge such as a steel stud or track against the insulation board in the proper location to guide the appropriate cutting tool (router, hot knife, or hot groover). **CAUTION: The thickness of the insulation board in the bottom of the reveal must not be less than 3/4 in (19 mm).**
3. Use Detail Mesh to ensure continuity of reinforcing mesh through aesthetic reveals continuing a minimum of 2 1/2 in (64 mm) on each side of the reveal.
 - a. Apply the base material mixture in the reveal and on the adjacent insulation board surfaces.
 - b. Embed the Detail Mesh into base coat mixture on one side of the reveal only.
 - c. Use a sled or special tool configured to the profile of the reveal. Embed the Detail Mesh into the base coat mixture through the reveal being careful not to cut the mesh.
 - d. Embed the Detail Mesh into the base coat mixture on the other side of the reveal. Ensure that the mesh is fully embedded and that all excess material is removed from the reveal.
 - e. Using a damp brush, smooth out any irregularities in the base coat.
CAUTION: If the mesh is cut in the reveal, a new piece of mesh must be installed over the cut or cracks can occur.

I. Preparation of Insulation Board for Base Coat Application

1. **IMPORTANT:** Once the insulation board and Detail Mesh are in place, wait a minimum of 24 hours prior to working on the surface of the insulation board to prevent any movement which may weaken the bond of the adhesive mixture to the substrate. **NOTE: Be sure to protect the installed insulation board from rain, freezing or inclement weather for a period of 24 hours.**
2. Any irregularities in the insulation board surface must be sanded flat. Sanding is accomplished with a light circular motion. **The entire wall area must be sanded.** Use grade 20 grit sandpaper or coarser, in conjunction with hand, electric or air rasps. Use OSHA required masks to protect against inhaling EPS dust. **NOTE: Do not sand parallel to the insulation board joints.**
3. Remove all loose pieces of insulation board and dust from the sanding operation using a brush, broom, vacuum, or compressed air. Use OSHA required masks to protect against inhaling EPS dust.
4. All Detail Mesh that was previously installed for back wrapping the insulation board shall be embedded in the base material mixture at this time.
 - a. With a stainless steel trowel, apply the base material mixture to the face (and edge if not previously coated) of the insulation board and embed the Detail Mesh in the wet mixture. **NOTE: It is not recommended to use NCB to embed reinforcing mesh at EPS edges that will receive sealant.**
5. Where Corner Mesh is specified for additional impact resistance at outside corners, the Corner Mesh shall be embedded in the base coat mixture and allowed to set prior to installing the overall reinforced base coat over the face of the wall.

IX. Installation of Reinforcing Mesh and Base Coat

A. General

1. Prior to installing the reinforced base coat, inspect the surface of the insulation board for:
 - a. Flatness: Use a minimum 8 ft (2.4 m) straight edge. Sand any high areas and out-of-plane board joints flat, as described in Section VIII.I.2 and 3. **CAUTION: Do not build up low areas with base coat mixture to form a flat surface.**
 - b. Damage and foreign materials: correct deficiencies as necessary.
 - c. Surface degradation due to weathering or UV (visible as discoloration). Sand affected areas to remove deterioration while maintaining the flatness of the surface.
2. **Do not apply the Dryvit materials in the rain. The insulation board must be dry prior to applying the base coat material.**
3. Mix the base coat material as described in Section III.C and D.

4. Prior to installing the reinforcing mesh, it should be inspected to ensure that it has been furnished by Dryvit Systems, Inc.
 - a. Dryvit reinforcing mesh is available in the following widths and lengths:
 - 1) Standard - 48 in x 150 ft (1.2 m x 45.7 m); 72 in x 150 ft (1.8 m x 45.7 m)
 - 2) Standard Plus, and Intermediate - 48 in x 150 ft (1.2 m x 45.7 m)
 - 3) Panzer 15 - 48 in x 75 ft (1.2 m x 22.9 m)
 - 4) Panzer 20 - 48 in x 75 ft (1.2 m x 22.9 m)
 - 5) Corner - 9 1/4 in x 150 ft (235 mm x 45.7 m)
 - 6) Detail - 9 1/2 in x 150 ft (241 mm x 45.7 m)

B. Base Coat Application

1. For system configurations 1, 2, or 3 where mechanical fasteners are used to secure the insulation board, all fasteners must be spotted with the Genesis or Genesis DM mixture prior to applying the base coat over the entire wall surface.
2. Standard Base Coat (single layer of Standard, Standard Plus or Intermediate Reinforcing Mesh)
 - a. The base coat shall be applied such that the resulting overall minimum base coat thickness is sufficient to **fully embed** the reinforcing mesh. The recommended method is to apply the base coat in two (2) passes.
 - b. Double pass method (recommended)
 - 1) Using a stainless steel trowel, apply the base coat mixture on the entire surface of the insulation board to an area slightly larger than the width and length of a piece of reinforcing mesh, in a uniform thickness of 1/16 in (1.6 mm). **NOTE: The reinforcing mesh may be installed either vertically or horizontally.**
 - 2) Immediately place the reinforcing mesh against the wet base coat mixture. With the curve of the mesh against the wall, trowel from the center to the edges avoiding wrinkles, until the mesh is fully embedded and not visible. Trowel smooth to a uniform thickness slightly more than the thickness of the reinforcing mesh. **NOTE: The reinforcing mesh shall be continuous at corners and mesh edges lapped not less than 2 1/2 in (64 mm). Do not lap the reinforcing mesh within 8 in (203 mm) of a corner. Tip: Corners and edges normally require light strokes with a small damp brush to smooth out irregularities.**
 - 3) Allow the base coat mixture to take up until firm to the touch. Trowel a second tight coat of the base coat mixture over the first coat to **fully cover** the reinforcing mesh - Figure 22. The result should be such that the reinforcing mesh is approximately centered within the base coat thickness. Do not allow the first pass to completely dry prior to the second pass application or an excessive amount of base coat mixture will be necessary to fully coat the wall surface.

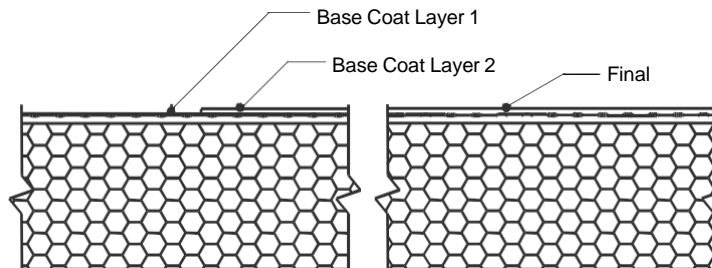

Figure 22

- c. Single pass method (optional)
 - 1) Apply the base coat as described in Section IX.B.2.b.1) and 2).
 - d. Protect completed work from water penetration and runoff.
 - e. Allow the base coat to cure a minimum of 24 hours before proceeding with application of finish coat. Cool, damp conditions may require longer drying times. Do not apply finish to a wet or damp base coat.
3. Panzer Mesh Base Coat (Panzer 15 or Panzer 20 used in conjunction with Standard or Standard Plus Reinforcing Mesh). **Panzer Mesh is recommended for use at all ground floor locations and at high traffic areas. Refer to contract documents.**
 - a. Using a stainless steel trowel, apply the base coat mixture on the entire surface of the insulation board to an area slightly larger than the width and length of a piece of reinforcing mesh, in a uniform thickness of approximately 1/8 in (3.2 mm).

- b. Immediately place the reinforcing mesh against the wet base coat mixture. With the curve of the mesh against the wall, trowel from the center to the edges avoiding wrinkles until the mesh is fully covered and not visible.
- c. Continue in the same manner until the entire area requiring Panzer Mesh is covered.
CAUTION: Do not lap the Panzer Mesh. Adjacent pieces are to be tightly butted.
- d. Protect completed work from water penetration and runoff.
- e. Allow the Panzer base coat to cure a minimum of 24 hours prior to applying Dryvit's Standard or Standard Plus Reinforcing Mesh.
- f. Apply the second layer of reinforcing mesh in accordance with Section IX.B.2.c. Offset the edges of the Standard or Standard Plus Reinforcing Mesh from the edges of the Panzer Mesh a minimum of 8 in (203 mm). **Tip: If Panzer Mesh is installed horizontally, we recommend the Standard or Standard Plus Mesh be installed vertically and vice versa.**

C. Installation of Dryflex base coat in high exposure areas such as sloped surfaces, window sills, etc.

- 1. Using a stainless steel trowel, apply the Dryflex mixture on the surface of the insulation board in a uniform thickness of approximately 3/32 in (2.4 mm). Apply the Dryflex continuously over the sloped surface and continue minimum 6 in (152 mm) onto the vertical areas.
- 2. Immediately place the reinforcing mesh against the wet Dryflex mixture. With the curve of the mesh against the wall, trowel from the center to the edges, avoiding wrinkles, until the mesh is fully covered and not visible. The overall minimum base coat thickness shall be sufficient to **fully embed** the reinforcing mesh. The recommended method is to apply the base coat in two (2) passes.
- 3. Allow the Dryflex to cure a minimum of 24 hours or until dry.

X. Sealant Joint Preparation

- A. All Outsulation RMD base coat surfaces which will be in contact with sealant must be coated with either Color Prime or Demandit Smooth.
 - 1. Mix Color Prime or Demandit Smooth in accordance with Section III.E and H respectively.
 - 2. Using a small brush, apply Color Prime or Demandit Smooth to the base coat surface that is to be in contact with the sealant and extending to the joint edge.
 - 3. Allow the Color Prime or Demandit Smooth to dry a minimum of 48 hours prior to applying the sealant. Cool damp weather may require longer drying times.
 - 4. Refer to sealant manufacturer's installation instructions for the proper application of the sealant and sealant primer.

XI. Dryvit Primers

- A. Prior to applying the Dryvit primers, the base coat shall have cured a minimum of 24 hours and shall be dry and hard. Cure time may be longer depending on environmental conditions. **NOTE: Refer to Product Data Sheets when applying over other materials.**
- B. Inspect the base coat for any irregularities such as trowel marks, board lines, rough corners and edges, improper reinforcing mesh embedment as well as efflorescence. **NOTE: Correct all irregularities and remove all efflorescence prior to applying the Dryvit primer.**
- C. Mix Dryvit Primers to a smooth homogeneous consistency in accordance with Section III.E.
- D. Color Prime and Weatherprime
 - 1. Apply with a brush, roller, or airless spray equipment. Refer to Color Prime or Weatherprime Data Sheets, [DS410](#) or [DS436](#) respectively, for complete instructions.
- E. Color Prime W
 - 1. Application with airless spray equipment is recommended. Refer to Color Prime W Data Sheet, [DS474](#), for complete instructions.
- F. Primer with Sand
 - 1. Application with a roller is recommended. Refer to Primer with Sand Data Sheet, [DS477](#), for complete instructions.

XII. Dryvit Finish

- A. Prior to applying the Dryvit finish, the base coat shall have cured a minimum of 24 hours and shall be dry and hard. Cure time may be longer depending on environmental conditions.
- B. Inspect the base coat for any irregularities such as trowel marks, board lines, rough corners and edges, improper reinforcing mesh embedment as well as efflorescence. **NOTE: Correct all irregularities and remove all efflorescence prior to applying the Dryvit finish.**

C. General

1. Important: All Dryvit finishes must be installed continuously to a natural break such as corners, expansion joints, or tapeline. Mechanics must maintain a wet edge. Whenever possible, order enough material in a single batch to complete the project to avoid potential color variations from batch to batch. Sufficient personnel and scaffolding must be provided to continuously finish a distinct wall area or otherwise cold joints will result. Scaffolding must be spaced a minimum of 18 in (457 mm) from the wall to prevent staging lines. On hot windy days, the wall may be fogged with clean potable water to cool the wall and facilitate finish installation. As with other plaster materials, installation work should precede the sun. For example, work the shady or cool side of the building. If this is not possible, scaffold should be shaded with a tarp or nursery shade cloth. Do not introduce water to the finish material once it is installed on the wall. This will cause color variations. Each mechanic must use the same tool and hand motion and match the texture of the mechanics above, below and on each side. Use finish from a single batch number whenever possible to avoid color match problems. If a different batch must be used, try to use on a different elevation.
2. Do not apply Dryvit materials in the rain. The base coat must be dry prior to applying the Dryvit finish or coatings.
3. Do not apply textured Dryvit finish material in sealant joints. Refer to Section X for proper preparation of the Outsulation RMD System at sealant joints.

D. Application

1. Mix the Dryvit finishes as described in Section III.
2. Quarzputz, Quarzputz E, Sandblast, and Weatherlastic Quarzputz
 - a. Using a clean stainless steel trowel, apply a coat of the Dryvit finish in a uniform thickness on the dry base coat. **NOTE: The Dryvit Quarzputz finish shall be applied and leveled to a uniform thickness no greater than the largest aggregate. The Sandblast finish is applied and leveled to a thickness of approximately 1 1/2 times the largest aggregate.**
 - b. The texture is achieved by uniform hand motion and/or tool that produces the texture to match the approved sample. Each mechanic must use the same tool and hand motion to ensure that the texture achieved is uniform over the entire wall area.
3. Sandpebble, Sandpebble E, Sandpebble Fine, Sandpebble Fine E, Weatherlastic Sandpebble, and Weatherlastic Sandpebble Fine
 - a. Using a clean, stainless steel trowel, apply an even coat of the finish to a thickness slightly thicker than the largest aggregate size.
 - b. Pull across using a horizontal trowel motion to develop a uniform thickness no greater than the largest aggregate of the material.
 - c. The texture is achieved by a uniform hand floating motion with a clean stainless steel trowel; wipe the trowel and wet it lightly. Apply light pressure in a circular motion.
4. Freestyle
 - a. Mix the Dryvit finish as described in Section III.F.
 - b. Using a clean, stainless steel trowel, apply the Freestyle finish on the base coat in a thickness not greater than 1/16 in (1.6 mm). The texture is either pulled out of this base to a thickness of no greater than 1/4 in (6.4 mm) or the texture may be achieved by adding more Freestyle finish to the base coat using the same texturing motions that are used with other plaster materials, such as, a skip trowel finish. Numerous other aesthetically pleasing textures can be created to match approved samples. **NOTE: The maximum thickness of Freestyle finish texture shall not exceed 1/4 in (6.4 mm).**
5. Weatherlastic Adobe
 - a. Using a brush, roller or airless spray equipment, apply a coat of color coordinated Color Prime (see Section III.E for mixing instructions) at the recommended coverage to the cured base coat and allow to dry.
 - b. Using a stainless steel trowel, apply a coat of Weatherlastic Adobe approximately 1/16 in (1.6 mm) to the wall surface. Allow the Weatherlastic Adobe finish to take-up.
 - c. Using a stainless steel trowel, apply a second coat of Adobe to obtain the desired texture. **Tip: An atomizing spray bottle may be used to apply a mist of water to the surface in the finishing step.**
6. Specialty Finishes: Ameristone, [DS142](#), Stone Mist, [DS420](#); TerraNeo, [DS481](#); Custom Brick, [DS154](#), and NewBrick, [DS871](#).
 - a. Mix the Specialty finishes as described in Section III.G.
 - b. Apply the specialty finishes in accordance with the products' Application Instructions or Data Sheets listed above.

XIII. Coatings and Sealers

NOTE: Coatings and Sealers are not intended to be applied directly over base coat; they are intended to be applied over Dryvit finishes.

- A. Mix coatings and sealers to a smooth homogeneous consistency in accordance with Section III.H.
- B. Demandit Smooth and Weathercoat
1. Apply with a brush, roller, or airless spray equipment.
 2. When applying with a roller, a maximum 3/4 in (19 mm) nap, polyester or polyester blend with nylon or lambswool, with beveled ends and a phenolic core is recommended. A 18 in (457 mm) wide roller frame with a 2 1/4 in (57 mm) inside diameter is also recommended.
 3. Apply in one continuous coat, maintaining a wet edge as the application proceeds to a natural break. The roller cover must be kept fully loaded as the application proceeds. **CAUTION: Do not stretch out the application by rolling with a dry roller. The last leveling roller strokes should always be in the same direction. Do not cut in around openings prior to overall application, but rather, do the cut-in work as the application proceeds.**
 4. Do not allow Demandit Smooth or Weathercoat to dry on roller covers. Roller covers with dried coating do not apply the coating evenly.
 5. Changing color requires the application of two coats (minimum).
- C. Demandit Sanded
1. Apply the Demandit Sanded with a brush or 1/2 in - 5/8 in (12.7 mm - 15.9 mm) nap roller.
 2. Roll or brush in multiple directions and then lightly finish in one direction to ensure that no lap marks remain.
 3. A second coat may be required for heavy textured surfaces or when there is a contrast of colors. Apply the second coat as described in paragraph XIII.B.2 and 3 above. **CAUTION: Do not attempt to apply Demandit Sanded in one heavy coat. Two coats are recommended. Apply the second coat only after the first coat is completely dry. Important: Texture changes will exist after Demandit Sanded is applied over existing Dryvit finishes. The degree of change is a function of the thickness and the number of coats of Demandit Sanded.**
- D. Weatherlastic Smooth
1. Apply a minimum 11 mils dry film thickness (22 mils wet film thickness). This is achieved by applying the Weatherlastic Smooth in two (2) 11 mil wet coats. Under average drying conditions, 70 °F (21 °C), 50 % RH, two (2) hours drying time between coats should be adequate.
 2. For cutting-in and trim, a nylon bristle brush is recommended.
 3. Roller Application
 - a. A minimum 10 in (254 mm) roller cover with a 1 1/4 in - 1 1/2 in (32 mm - 38 mm) nap is recommended.
 - b. Completely saturate the roller cover and keep the roller loaded with coating to avoid foaming. Do not dry-roll or over-roll as this will cause excessive entrapment of air within the coating.
 - c. A second coat is applied in a similar manner after the first coat has adequately dried.
 4. Spray Application
 - a. Application by airless spray equipment or mastic pump and gun allows application of coating at total required application rate with a minimum of stipple or thickness variations.
 - b. Equipment should have the capacity to pump 2 gal (7.6 L) of coating per minute.
 - c. Material hose should be minimum 1/2 in (12.7 mm) inside diameter for spraying coating through more than a 50 ft (15 m) length. Minimum bursting of 800 lbs (360 kg) is recommended. **Tip: Orifice sizes of .021 in - .032 in (0.53 mm - 0.81 mm) will be required depending on equipment used.**
 - d. Cross apply coating holding spray gun perpendicular to, and approximately 3 ft (1 m) from the wall surface. Avoid excessive material build-up by holding spray gun away from the wall when pulling the trigger, then bringing gun across area to be coated. Maintain a wet edge and avoid starting and stopping in the middle of the wall. Do not attempt to overreach spray pattern as this may result in appearance of irregular spray pattern. Place scaffolding and equipment to facilitate quick application without numerous interruptions.
 - e. A 10% loss from overspray should be anticipated.
 - f. Backrolling sprayed areas is recommended to control pinholing on spray applications over porous surfaces.
- E. Tuscan Glaze
1. Mix Tuscan Glaze to a smooth homogenous consistency in accordance with Section III.H.2. Continuously agitate throughout application to ensure color consistency.
 2. Tuscan Glaze is best applied on large areas using a Hudson-type sprayer or airless spray equipment. For smaller areas, Tuscan Glaze is best applied with a paint pad or, depending on the desired results, a roller, paint brush or sponge. Job site mock-ups are required and should represent the actual job site application techniques.

3. Apply Tuscan Glaze evenly in light strokes. If sagging or running occurs, use a sponge or paint pad to correct immediately. Watch for brush or roller lines. If brush or roller lines appear, use a damp sponge, a paint pad or rag to make them disappear before the Tuscan Glaze starts to dry. The wall may be blotted with a camelback sponge to achieve the desired mottled appearance. Check walls throughout the application to insure that uniformity and the desired appearance is achieved.

F. SealClear

1. Mix SealClear to a smooth, homogeneous consistency in accordance with Section III.H.3.
2. For application instructions, refer to the SealClear Data Sheet, [DS426](#).

XIV. Maintenance and Repair

- A. Refer to DryvitCARE EIFS Repair Procedures, [DS498](#).

DISCLAIMER

Information contained in this document conforms to standard detail and product recommendations for the installation of the Dryvit Outsulation RMD System products as of the date of publication of this document and is presented in good faith. Dryvit Systems, Inc. assumes no liability, expressed or implied, as to the architecture, engineering or workmanship of any project. To insure that you are using the latest, most complete information, contact Dryvit Systems, Inc., at:

One Energy Way
West Warwick, RI 02893
(401) 822-4100

